

PEOPLE HAVE PRIORITY



Instructions for Use



CE

assistina
301 plus

Contents

Symbols	4
In the instructions for use	4
On the medical device	5
On the packaging/cartridge	6
1. Introduction	7
2. Unpacking	9
3. Scope of delivery	10
4. Safety notes	11
5. Description	12
Front side	12
Rear side.....	13
6. Start-up	14
Initial filling	17
7. Operation	20
Maintenance process	20
Attaching / removing the adaptor	21
Maintenance process	22
Lubrication of chucking system.....	24
8. Cleaning	25
9. W&H accessories	26

10. Maintenance	28
O-rings replacement	29
Filter replacement	30
Air filter replacement	31
11. Servicing	32
Returns	32
Preparation of returns	33
12. Technical data	34
13. Disposal	35
Explanation of warranty terms	36
Authorised W&H service partners	37

Symbols

In the instructions for use



WARNING!
[risk of injury]



ATTENTION!
[to prevent damage occurring]



ATTENTION!
General explanations
with no danger to persons or property



CE mark



Do not dispose with domestic waste



WARNING!
Flammable liquid and vapour

Symbols

On the medical device



Consult instructions for use



DataMatrix Code
for product information
including UDI (Unique
Device Identification)



Catalogue number



Date of manufacture



Serial number



CE mark



Manufacturer



Medical device

Symbols

On the packaging/cartridge



This way up



Fragile, handle with care



Keep dry



® “Der Grüne Punkt” (The Green Dot) trademark of Duales System Deutschland GmbH



Trademark of RESY OfW GmbH for identification of recyclable transport and outer packaging of paper and cardboard

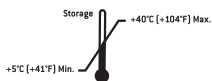

Permitted temperature range for storage



CE mark



Medical device



Consult instructions for use



Manufacturer



Caution! According to Federal law, this medical device may only be sold by or on the order of a dentist, physician or any other medical practitioner licensed by the law of the State in which he or she practices and who intends to use or order the use of this medical device.



Keep away from heat



Use by



WARNING!
Flammable liquid and vapour



EUH210 safety data sheet available on request

1. Introduction

For your safety and the safety of your patients

Prior to initial use please read the Instructions for use. These explain how to use your medical device and guarantee a smooth and efficient operation.



Observe the safety notes.

Intended use

Unit for cleaning the spray channels and lubricating the moving parts of dental transmission instruments, turbines, air motors and air-driven dental scalars.



Misuse may damage the medical device and hence cause risks and hazards for patient, user and third parties.

When transmission instruments are prepared with the medical device, they are neither disinfected nor sterilized. After cleaning of the spray channels and lubrication of the transmission instruments with the medical device, they subsequently need to be disinfected and sterilized.

Qualifications of the user

We have based the development and design of the medical device on the target group of dentists, dental hygienists and dental assistants.

Introduction



Production according to EU Directive

The medical device meets the requirements of Regulation (EU) 2017/745

Responsibility of the manufacturer

The manufacturer can only accept responsibility for the safety, reliability and performance of the medical device when it is used in compliance with the following directions:

- > The medical device must be used in accordance with these Instructions for Use.
- > The medical device has no components that can be repaired by the user (with exception of replacing the o-rings, cartridges, filter and air filter). Assembly, modifications or repairs must only be undertaken by an authorised W&H service partner. (see page 37)
- > Unauthorized opening of the medical device invalidates all claims under warranty and any other claims.

Improper use, unauthorized assembly, modification or repair to the medical device, non-compliance with our instructions or the use of accessories and spare parts which are not approved by W&H, invalidates all claims under warranty and any other claims.



Any serious incident that has occurred in relation to the medical device should be reported to the manufacturer and the competent authority!

2. Unpacking

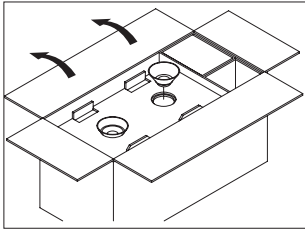

Have the Instructions for Use at hand. Take out the white and green funnels.

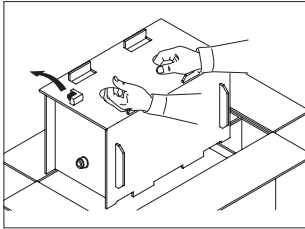

Remove the basic adaptor.
Lift out the Assistina in the fibre-board box.

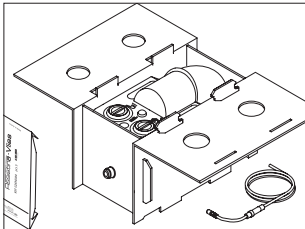

Open the box at the tucked-in closure and remove the air hose from the cover. Remove the initial accessories.

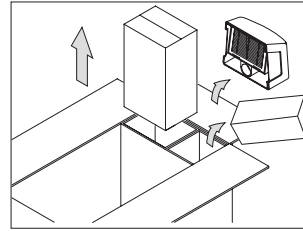

Take out the service oil, cleaning liquid, suction filter and the optional accessories from the side compartments.

The W&H packaging is environmentally friendly and can be disposed of through specialist recycling organizations.

However, we recommend that you keep the original packaging.

3. Scope of delivery

- > W&H Assistina maintenance unit (REF 00030125, 00030140)
- > Suction filter, complete
- > Basic adaptor REF 02685000
- > Funnel, white, REF 02689300
- > Funnel, green, REF 02689400
- > Air connection hose 2 m, REF 02697000, complete
- > Initial provision of 5 layers of fleece REF 02690300
- > 2 spare seals REF 02680600 and
2 spare O-rings REF 02695700
- > Instructions for Use with warranty card

4. Safety notes



Please observe the following instructions under all circumstances

- > Only set up the product in sufficiently well ventilated rooms!
- > Keep the device closed during the maintenance process!



GHS02 WARNING!

H226 Flammable liquid and vapour

- > P210 Keep away from heat, hot surfaces, sparks, open flames and other ignition sources. No smoking.
- > P233 Keep container tightly closed.
- > P280 Wear protective gloves / eye protection.
- > P403 + P235 Store in a well-ventilated place. Keep cool.
- > P 501 Dispose of contents / container in accordance with local / regional / national / international regulations.



- > Place the medical device on a flat, level surface.

5. Description

Front side

Filler hole /
storage container
for service oil

Button to cleaning /
maintenance process

Fill level of
service oil

Indicator window
for service oil

Waste disposal
tray

press
2 sec./
cycle

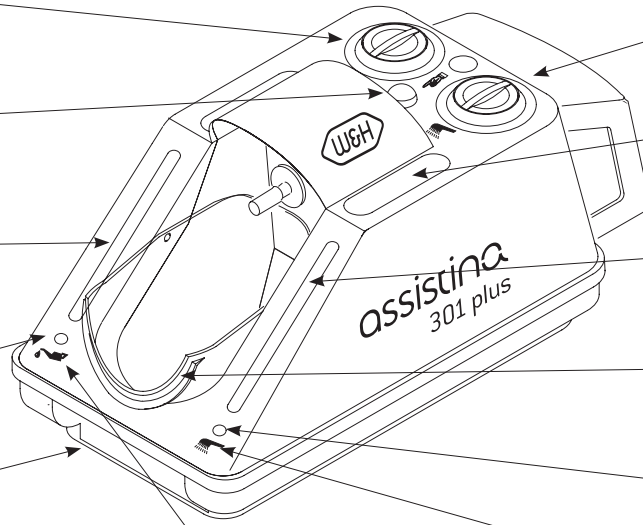

Filler hole /
storage container
for cleaning liquid

Recess for
adaptor

Fill level of cleaning
liquid

Cover

Indicator window
for cleaning liquid

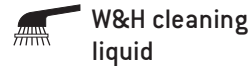
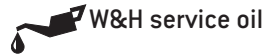

Description

Rear side

Suction filter

Quick release
coupling for
compressed air

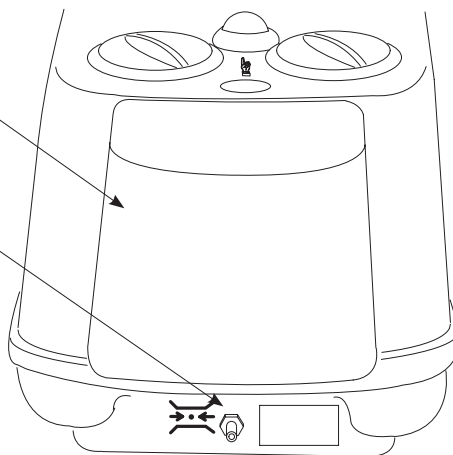

6. Start-up



- > Service oil must be at room temperature when it is poured in.
- > Never reverse funnels (white to white, green to green) and store them in a dust-free environment!
- > Check the filling level indicator!

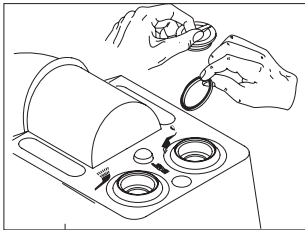

Unscrew the two caps and remove the two transport seals (malfunction!!)

Start-up

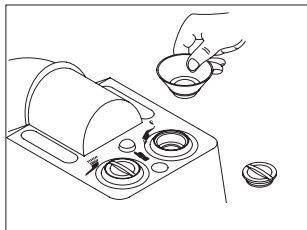

Unscrew the cap from the white storage container.
Insert the white funnel.

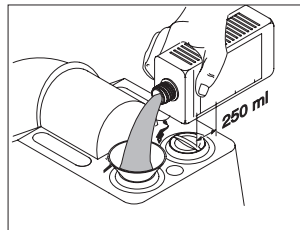

Add 250 ml of cleaning liquid.

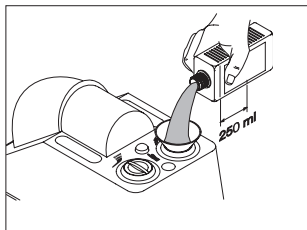

Add 250 ml of service oil.

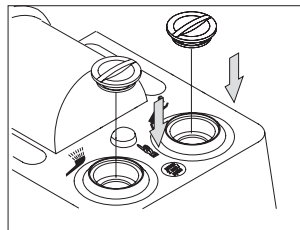

Close the storage containers
for the service oil and
cleaning liquid.

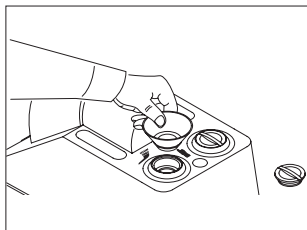

Unscrew the cap from the
green storage container.
Insert the green funnel.

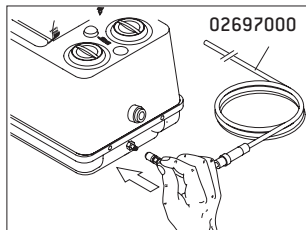

Push the quick release coupling of the connecting hose into the coupling socket on the Assistina. Connect the compressed air line.

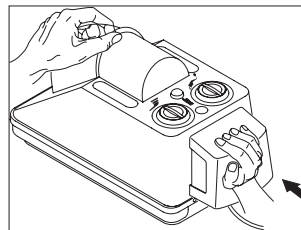

Fit the suction filter so that it is leak-tight.



The built-in air filter in the connecting hose is only a fine filter. It cannot clean unfiltered and possibly contaminated compressor air. Dirty fine filters must be replaced.



> Use only non-contaminated, oil-free, dry and filtered compressed air according to ISO 7494-2.

Start-up

Initial filling

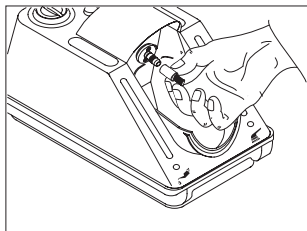

Pull the drip guard off the maintenance attachment and store it safely. Close the cover.

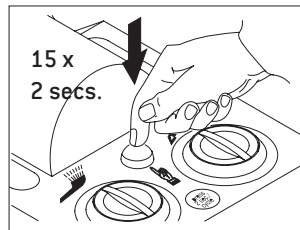

Press the start button about 15 times for 2 seconds with a pause of 2 seconds between each actuation.



If no fluid can be seen or detected on the waste disposal tray, the supply lines are not yet completely full.

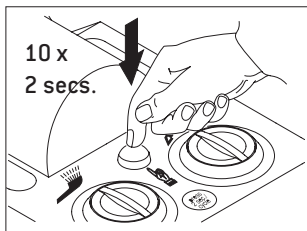

Press the start button 10 times for 2 seconds.



- > Do not connect any transmission instrument, turbine, air motor or dental scaler during the test!
- > If the adaptor is fitted on the maintenance attachment, remove it.

Start-up

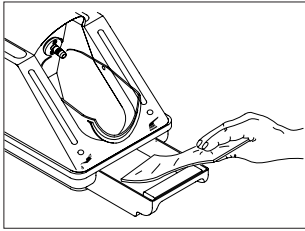

Place a fleece inlay in the waste disposal tray.

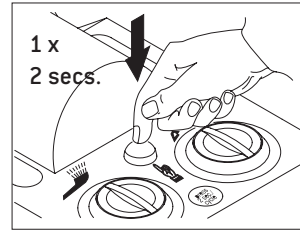

Press the start button once for 2 seconds.

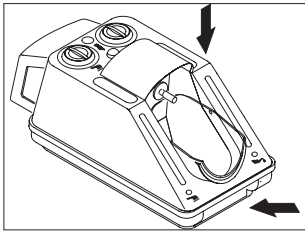

Close the cover and waste disposal tray.



Check that the fleece inlay is damp to ensure correct function.

If it is not damp, repeat the process 2 to 3 times.

Dispose of saturated fleece inlays as with cloths for surface disinfection.



In the event of operating malfunctions (e.g., vibrations, unusual noise, overheating, failure or leakage) stop the medical device immediately and contact an authorized W&H service partner.

Start-up

Function display

Continuously monitor the function display!

- > Press the start button for 2 seconds.
A green ball for the cleaning liquid appears in the right-hand window.
- > Release the start button.
A green ball for the service oil appears in the left-hand window.



After a few seconds, both balls will drop down again.

Correct operation of the maintenance process is indicated by these two function displays.

If ever the balls disappear during a program cycle, this indicates a malfunction.

Function check of the mechanical drive

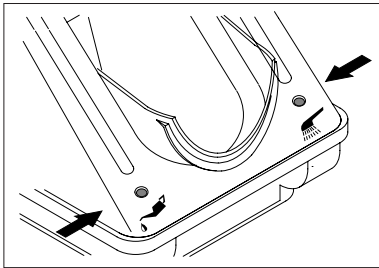

> Fit a transmission instrument with a rotary instrument inserted onto the Assistina maintenance attachment.

> Press the start button for 2 seconds.



The maintenance cycle begins and the rotary instrument turns.

If the rotary instrument does not turn, there is a malfunction.

7. Operation

Maintenance process



- > Wear protective clothing, safety glasses, face mask and gloves.
- > Refer to the »hygiene and maintenance« instructions in the Instructions for Use of the transmission instruments.

Transmission instruments with ISO coupling

The maintenance program will be completed in about 35 seconds.

- > Pull down cover.

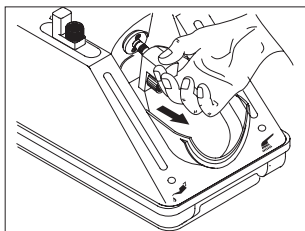

Press the green release button and pull off the basic adaptor. Keep the adaptor in the recess.

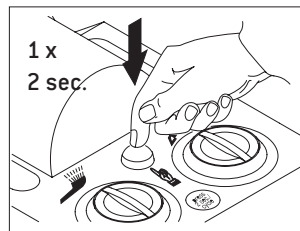

Press the start button once for about 2 seconds. Open the cover at the end of the maintenance cycle.

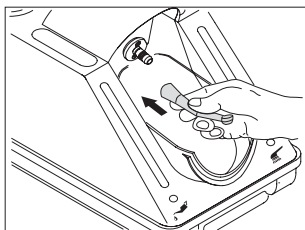

With its spray exit nozzle directed downwards, push the transmission instrument onto the maintenance attachment up to the limit stop. Close the cover and the waste disposal tray.

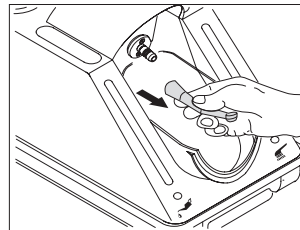

Press the green release button of the maintenance attachment while at the same time removing the transmission instrument.

Operation

Attaching / removing the adaptor

Turbines

The maintenance program will be completed in about 35 seconds.

> Use the basic adaptor REF 02685000 with standard 4-hole connection.

> Pull down cover.

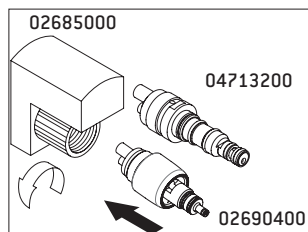

W&H turbines:

Screw together the basic adaptor and the adaptor.
Adaptors not suitable for use with turbine hose.

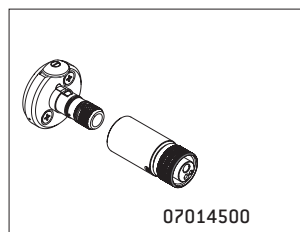

Turbines with

- > 2-hole or 3-hole Borden connection and
- > spray air to drive air connection

Screw the basic adaptor to the turbine. Insert the turbine adaptor onto the motor attachment.

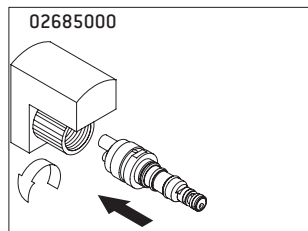

Other turbines:

Screw the basic adaptor to the relevant quick release coupling (e.g. adapter 02692000, 04713200 ...).

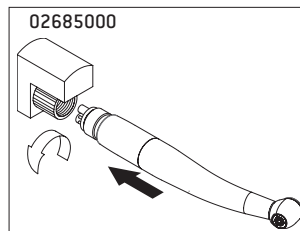

Turbines with standard 4-hole connection:

Screw the basic adaptor onto the respective turbine

Operation

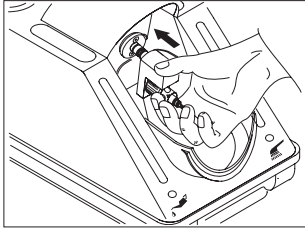

Push the appropriate adaptor onto the maintenance attachment up to the limit stop.

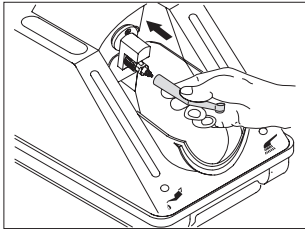

With its spray exit nozzle directed downwards, push the turbine with quick release coupling onto the adaptor until it engages. Close the cover and the waste disposal tray.

Maintenance process

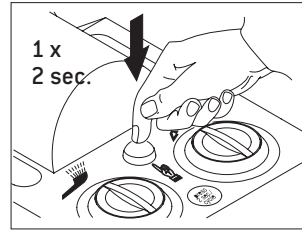

Press the start button once for about 2 seconds. Open the cover at the end of the maintenance cycle.

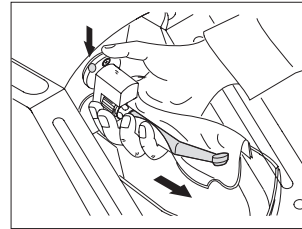

Press the green release button of the maintenance attachment, while at the same time removing the turbine from the adaptor.

Air motors and air-driven dental scalers

The maintenance program will be completed in about 35 seconds.

- > Use the basic adaptor REF 02685000 with standard 4-hole connection.
- > Set the rotary ring of the air motor to clockwise or anticlockwise running (no maintenance will take place in the »Zero« setting).
- > Carry out maintenance as for turbines (see page 21).

Operation

Lubrication of chucking system



FG contra-angle handpieces

- > Remove the rotary instrument.
- > Use the adaptor 02693000



- > Wear protective clothing, safety glasses, face mask and gloves.

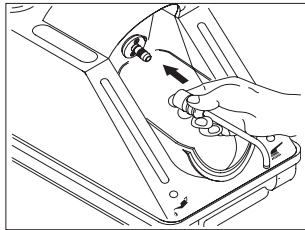

With its spray exit nozzle directed downwards, push the adaptor onto the maintenance attachment. Initially, keep the cover open.

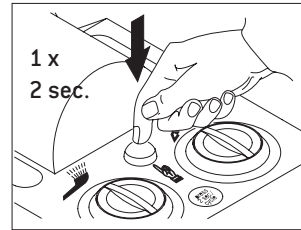

Press the start button once for about 2 seconds.

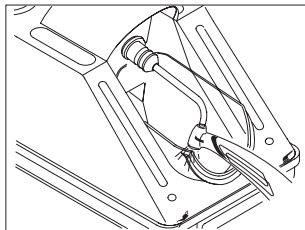

Push the transmission instrument onto the adaptor from underneath. Support the transmission instrument at the edge of the cover.

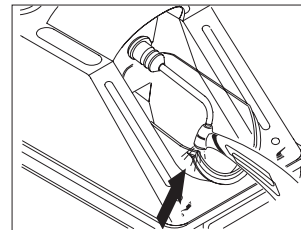

Press the transmission instrument against the adaptor for about 10 seconds. Close the cover. Allow the remainder of the maintenance cycle to complete.

8. Cleaning



Follow your local and national laws, directives, standards and guide lines for cleaning and disinfection.



> Wear protective clothing, safety glasses, face mask and gloves.



Cleaning agents

> Use only detergents which are intended for cleaning medical devices made of metal and plastic.

W&H recommends external cleaning of the Assistina

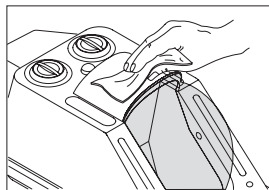

- > once a week or as required.
- > Use W&H cleaning liquid to clean the outside of the case.

Clean the cover and the waste disposal tray

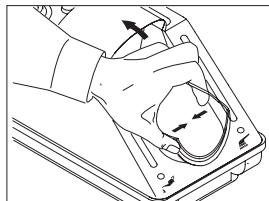

- > as required
- > Squeeze the cover slightly.
- > Remove the cover from its fixing.
- > Use W&H cleaning liquid to clean the inside of the case.
- > Clean the waste disposal tray in a thermo washer disinfectant.

9. W&H accessories



Use only original W&H accessories / spare parts or accessories approved by W&H

Optional accessories

- 02676400 Drip guard for maintenance attachment
- 02679000 Adaptor for removable contra-angle handpiece heads

- 02680600 Seal
- 02685000 4-hole basic adaptor
- 02689300 Funnel, white
- 02689400 Funnel, green

- 02690400 Adaptor for all W&H products with Roto Quick system
- 02691000 Adaptor suitable for transmission instruments T1 CLASSIC from Sirona Dental Systems
- 02692000 Adaptor suitable for turbine handpieces from the series T1, T2, T3 from Sirona Dental Systems

- 02693000 Adaptor chucking system
- 05204600 Entran contra-angle head
- 02697000 Air connection hose 2 m
- 04713200 Adaptor suitable for Multiflex connection from Kaltenbach & Voigt
- 07014500 Adaptor Assistina Borden

W&H accessories

- 02675200** Air filter for air connection hose 02697000
- 02695700** O-ring for maintenance attachment

- 02670500** Filter pack
- 02675910** 500 ml W&H service oil
- 02680200** 1000 ml W&H cleaning liquid
- 02680500** Pack of W&H service oil and W&H cleaning liquid
- 02690300** Initial provision of 5 layers of fleece
- 02694500** Fleece, pack of 20

10. Maintenance

Regular testing of Assistina

Regular testing of function and safety is necessary:

With each application:

- > Check the function display

Once a week:

- > Check the filling level displays.

Once a year:

- > Carry out a function check (page 19).
- > Check the fine filter in the air connection hose for contamination.

Maintenance

O-rings replacement



- > Replace damaged or leaking O-rings immediately.
- > Do not use sharp tools!

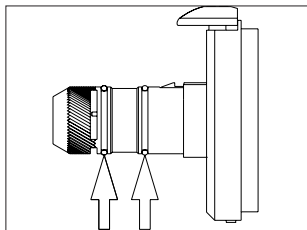

Check the O-rings on the maintenance attachment. Change the O-rings in the event of visible defects or every two months. Replace any missing O-ring immediately.

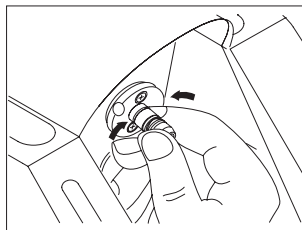

Firmly squeeze the O-ring between thumb and forefinger and pull it off. Push on a new O-ring.



The O-rings can be exchanged without the need for special tools. Grease-free fingers will facilitate this exchange.

2 replacement O-rings
No. 02695700
are attached here.



Renewing the filter pack

- > Do not touch the vents of the suction filter (risk of damage)!
- > Use the W&H Assistina for maintenance only when the suction filter with a fully serviceable filter pack is fitted.

> Renew the filter pack in the suction filter after approx. 7,000 maintenance cycles (corresponds to the consumption of a 500 ml bottle of W&H service oil).

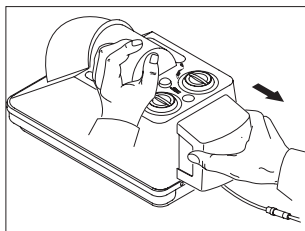

Pull out the suction filter horizontally towards the rear.

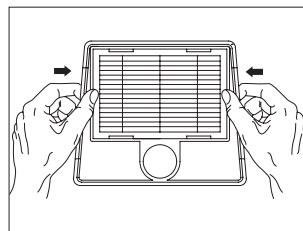

Take the filter pack out of its packaging. Press the filter pack on the frame in the filter case. Refit the suction filter so that it is leak-tight.

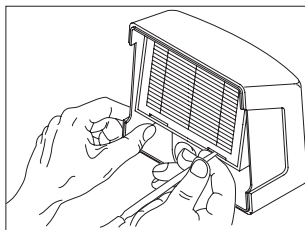

Press out the filter pack using a suitable implement. Ensure that it is placed in the correct waste disposal.

Maintenance

Air filter replacement



Switch off the central air supply before replacing the air filter.



> Replace the air filter whenever it is dirty or at least 1x per year.

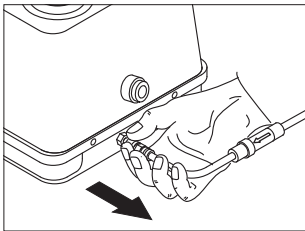

Press the ring downwards. At the same time, pull out the air connection hose.

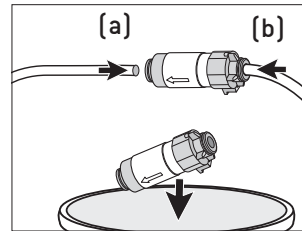

Replace the air filter and re-connect the air hose [a, b].

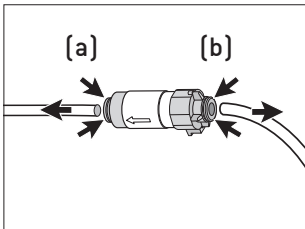

Push the ring [a, b] towards the air filter and detach the air hose.

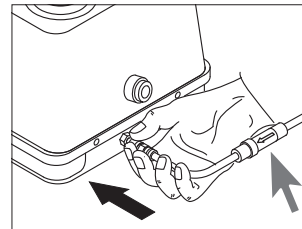

Connect the air hose.



Pay attention to the flow direction of the air filter.

Returns

> If you have any questions, please contact your local dental dealers or one of our service points. (see page 37)



Always return equipment in the original packaging.

2 transport seals
No. 02680600
are attached here.

Servicing

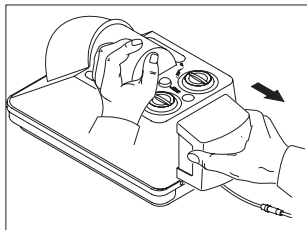

Pull out the suction filter horizontally.

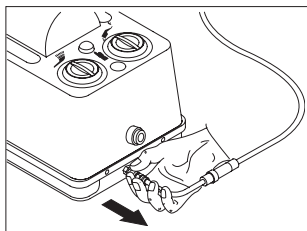

Disconnect the air connection hose.

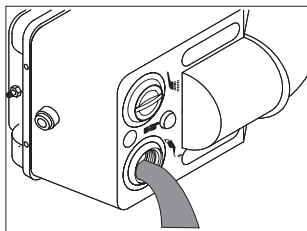

Empty the cleaning liquid and service oil from the storage containers. Do not empty the containers simultaneously. The cleaning liquid and service oil must not be mixed!

Preparation of returns

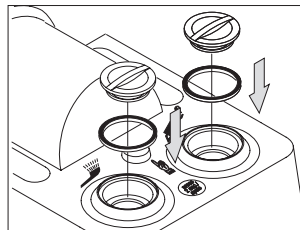

Fit a seal in each filler hole. Screw on the two caps. Before emptying the first container, fit the transport seal on the second container.

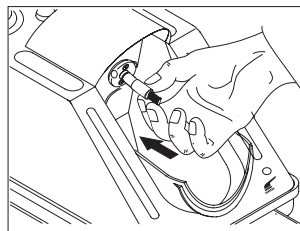

Fit the drip guard No. 02676400 on the maintenance attachment.

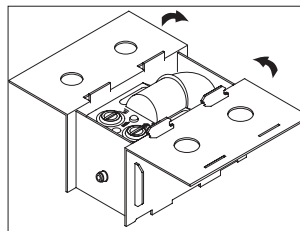

If its packaging no longer available:
Ask your dealer for W&H packaging or use secure substitute packaging.

12. Technical data

Height:	223 mm
Width:	190 mm
Depth (with filter):	415 mm
Weight:	2.70 kg
Air consumption:	approx. 60 NI/min.
Noise:	63 dB (A) (at 50 cm distance)
Flow pressure:	4 bar to 10 bar (pressure regulation provided by integral automatic pressure regulator)
Capacity:	250 ml W&H service oil F1, sufficient for approx. 3,500 maintenance cycles 250 ml W&H cleaning liquid, sufficient for approx. 2,500 maintenance cycles

Ambient conditions

Temperature during transport:	0°C to +50°C (+32°F to +122°F)
Temperature during storage:	+5°C to +40°C (+41°F to +104°F)
Temperature during operation:	+10°C to +40°C (+50°F to +104°F)

13. Disposal



Ensure that the parts are not contaminated on disposal.



Follow your local and national laws, directives, standards and guidelines for disposal.

> Medical device



> Packaging

Explanation of warranty terms

This W&H medical device has been manufactured with great care by highly qualified specialists. A wide variety of tests and controls guarantee faultless operation. Please note that claims under warranty can only be validated when all the directions in the Instructions for Use have been followed.

As the manufacturer, W&H is liable for material or manufacturing defects within a warranty period of 12 months from the date of purchase. Accessories and consumables are excluded from the warranty.

We accept no responsibility for damage caused by incorrect handling or by repairs carried out by third parties not authorized to do so by W&H!

Claims under warranty accompanied by proof of purchase must be sent to the vendor or to an authorized W&H service partner. The provision of service under warranty extends neither the warranty period nor any other guarantee period.

12 months warranty

Authorised W&H service partners

Find your nearest W&H service partner at <http://wh.com>
Simply go to the menu option »Service« for full details.

Or simply scan the QR code.



Manufacturer

W&H Dentalwerk Bürmoos GmbH
Ignaz-Glaser-Straße 53, 5111 Bürmoos, Austria

t +43 6274 6236-0, f +43 6274 6236-55
office@wh.com wh.com

Form No. 50458 AEN
Rev. 019 / 09.03.2020
Subject to alterations