

Original Operating Manual HTS-2/M/Zirkon-120

EN



Contents

General information	4
Limitation of liability	4
Responsibilities of the operator	4
Documentation	5
Content and structure	5
Labelling scheme for integrated text boxes and references	5
Formatting and symbols	6
Service address	6
Safety	7
Requirements for personnel	7
Transport, packaging and storage	9
Transport	9
Packaging	10
Storage	10
Technical description	11
Function	11
Conformity	12
Certification	13
CE Mark	13
EAC Certification	13
RoHS Conformity	13
Intended use	14
Potential misuse	14
Technical data	15
Operating conditions	15
Installation	16
Installation location	16
Installation conditions	16
Electrical connection	17
Local installation	17
Rating plate	18
Operation	19
Operating elements and displays	19
Switches and button functions	20
Standby screen	21
Switch on Sintering Oven	21
Program slot structure	21
Initial commissioning	22
Using the door insulation	22
Sintering aids	23
Sintering process	23
Sintering Oven Feeding	23
Selecting and loading a heating program	24
Starting/stopping a heating program	24
Removing the sintering dish from the heating oven	25
Programming the heating levels	26
Programming levels S2 to S4	27
Saving the heating program	27
Linear cooling	28

Saving the heating program with a name	28
Renaming the heating program	29
Starting a heating program automatically	30
Special functions	31
Sintering with ventilation	31
Preliminary drying without sintering	31
Preliminary drying with sintering	31
Basic settings	32
Parameter settings	32
Switching off Sintering Oven	35
RS-232 interface	36
Care and maintenance	44
Service programs	44
Faults and error messages	45
Safety	45
Faults	46
Error messages in the electronics	47
Decommissioning	48
Disposal	48
Safety	48
Disposal	48

General information

Limitation of liability

The content of this operating manual has been created taking the applicable laws and standards into account.

The unit has been developed using state-of-the-art technology.



NOTICE

The manufacturer assumes no liability for damage resulting from:

- Disregard/non-observance of the operating manual
- Intentional misuse
- Use other than as intended
- Operation by untrained personnel
- Operation by non-professionals (to carry out maintenance work, etc.)
- Technical modifications to the unit that have not been agreed with the manufacturer
- Use of replacement parts that have not been approved by the manufacturer

Responsibilities of the operator

The unit is used for commercial purposes. The operator of the unit is therefore subject to the statutory obligations relating to occupational safety. In addition to the safety instructions in this operating manual, the regulations on safety, accident prevention and environmental protection that apply to the unit's area of application must be complied with.

In particular, the following apply:

- The operator must be familiar with the applicable regulations on occupational safety.
- The operator must ensure that all employees who use the unit have read and understood this operating manual.
- The operator must also train personnel at regular intervals and inform them of the dangers that can arise when using the unit.
- The operator must provide personnel with the necessary protective equipment.
- The operator must have all safety devices checked regularly for operability and completeness.

Documentation

Content and structure

This operating manual is an essential part of this unit. It contains instructions and information on how to use the unit safely and must be available to all users throughout the unit's service life. This operating manual is intended for use by trained operating personnel.

Labelling scheme for integrated text boxes and references

The following safety notices are used in this manual:



DANGER

Indicates an imminent danger that may cause serious physical injury or death.



WARNING

Indicates a potentially dangerous situation that may cause serious physical injury or death.



CAUTION

Indicates a potentially dangerous situation that may cause minor physical injury.



NOTICE

Indicates a potentially harmful situation in which the product or an object in its vicinity may be damaged.

NOTICE

Information or tips for easier operation.

Formatting and symbols

- ⚠ *indicates a general safety instruction*
- ☑ indicates that a requirement must be met
- 1. indicates a step to be carried out
- ➔ indicates the outcome of carrying out a step
- indicates a list
- S1** indicates a button

Service address



Friedrich-List-Straße 8
D-76297 Stutensee-Blankenloch
Tel.: +49 (0) 7244 70871-0
www.mihm-vogt.de

Safety

The **sintering oven** is a high-temperature oven for commercial use in dental laboratories and may only be used for sintering sinterable ceramics.

Requirements for personnel

Trained and qualified personnel who know how to use the unit and whose specialist training, skills, experience and knowledge of the relevant regulations enables them to carry out the tasks assigned to them independently and recognise and avoid potential hazards.



DANGER

Electricity!

Risk of death from electric shock.

- Do not touch live cables and components with wet hands.
- Observe the accident-prevention regulations when working with electric current.
- Before carrying out any installation, maintenance, cleaning or repair work, disconnect the power supply of the **sintering oven** and secure it against being switched back on.



DANGER

Risk of ignition!

Use of inflammable and explosive materials near the oven.

- Do not operate the **sintering oven** near highly inflammable sources.
- Do not install the **sintering oven** on highly inflammable supporting surfaces.



WARNING

Risk of burns from hot surfaces!

The surfaces of the **sintering oven** become hot during operation. These may cause burns if touched.

- Do not touch the housing or the oven door during operation.
- Do not reach into the heating chamber. It may still retain a high level of residual heat from the previous heating process.
- Ensure that the **sintering oven** has cooled down before carrying out maintenance, cleaning and repair work.
- Wear heat-resistant safety gloves if it is necessary to carry out work on hot components.
- Use a suitable and sufficiently long pair of tongs to place the sintering dish in the oven and remove it from the oven.



CAUTION

Incorrect operation!

No liability is assumed for damage that may be caused by misuse, incorrect operation, incorrect connections or improper maintenance/repair work carried out by untrained personnel. All warranty services are also excluded in such cases.

The unit must not be used if it or the mains cable becomes damaged and no longer functions correctly.

In this case contact the manufacturer immediately.

For your own safety and to increase the service life of your unit, use only original replacement parts.

To ensure safe operation of **the sintering oven**, regional regulations (e.g. accident-prevention regulations) apply in addition to the instructions in this operating manual. The former must be made available by the operator of the unit. The safety notices on the **sintering oven** must be kept in a legible condition.



NOTICE

This operating manual must be read and understood by each user before working on and with the unit.

The operating manual must be kept for the specified service life of the **sintering oven**.

Transport, packaging and storage

Transport



WARNING

Injury due to the sintering oven falling down!

Slipping/falling when lifting and carrying the sintering oven can lead to serious injuries.

- Only carry/hold the sintering oven at the lower edge of the housing (base).
- Always have at least 2 persons carry the sintering oven (max. 30 kg/person).



CAUTION

Risk of injury due to oven weight!

Physical strain/back injuries due to the high inherent weight.

- Have at least two people carry/move the *sintering oven* together.



NOTICE

Transport damage!

To prevent injury to personnel and material damage:

- Transport the unit in an upright position only.
- Do not stack units on top of each other.
- Do not place any other objects on the unit.
- Transport must be as free of shaking and vibrations as possible to prevent the unit from being damaged.
- Make sure that the unit is secured against slipping and falling during transport.
- The goods must be inspected for damage and loss immediately upon receipt. Defects must be documented by the freight carrier on the letter of consignment in order to lodge claims. Mihm-Vogt GmbH & Co.KG assumes no liability for any damage and loss that is only found subsequently.

Packaging



NOTICE

The packaging protects the **sintering oven** against transport damage, corrosion and other forms of damage. Only remove it shortly before initial commissioning and store it in dry conditions for later reuse.

Storage



NOTICE

Temperature damage!

To prevent temperature damage:

- Store the unit only at temperatures between +5 and +40 °C.
- Always store the unit in dry and dust-free conditions.
- Avoid exposure to direct sunlight.
- Avoid mechanical vibrations.

Technical description

Function

The **sintering oven** is used to fire sinterable ceramics.

The product to be sintered is placed in the sintering dish and set on the support discs. The electrically powered oven door closes and the heat-up process starts after entering the heating parameters and pressing the Start/ Stop button.

Once the heating program has ended and the **sintering oven** has cooled down, the oven door opens and the finished product can be removed.

Heating chamber

The product is sintered in the heating chamber. This consists of two different ceramic insulation layers and is operated using MoSi₂ heating elements. The outer insulating layer is designed for temperatures up to 1200 °C; the inner layer for temperatures up to 1700 °C.

Oven door

The oven door consists of a three-part ceramic door panel. A safety switch disconnects the heating current as soon as the oven door is opened.

A slip clutch used in the drive mechanism prevents too high a contact pressure between the oven door and heating chamber.

Oven housing

The oven housing consists of steel plate coated with plastic on both the inside and the outside.

Program controller

The program controller has a finishing-time setting that can be used to specify a day and time for the program to finish. The switch-on time is calculated automatically so that the heating process is stopped at the required time and the sintered item can be removed.

Operating parameters and heating programs are stored in a non-volatile memory and are retained even if the power supply fails.

The set target temperature is maintained within an accuracy of ± 1 °C.

A temperature sensor integrated into the heating chamber measures the temperature of the chamber close to the product.

A thermocouple fail-safe prevents the **sintering oven** from overheating if the temperature sensor becomes defective.

Conformity



EC Declaration of Conformity according to Machinery Directive 2006/42/EC Annex II 1.A

The manufacturer / distributor

MIHM-VOGT GmbH & Co. KG
Friedrich-List-Str. 8
76297 Stutensee
Tel.: +49 (0) 72 44/7 08 71-0
Fax: +49 (0) 72 44/7 08 71-20
Email: info@mihm-vogt.de

hereby declares that the following
product

Product designation: Sintering oven
Make: HTS-2/M/Zirkon-120

Description:

The sintering oven is a high-temperature oven for commercial use in dental laboratories and may only be used for sintering sinterable ceramics.

corresponds to all relevant regulations of the above directive as well as the further applied directives (below) – including their amendments applicable at the time of the declaration.

The following EU directives were applied: EMC

2014/30/EU
RoHS 2011/65/EU

The protection objectives of the Low Voltage Directive 2014/35/EU were complied with.

The following harmonised standards were applied:

EN 61010-1:2010	Safety requirements for electrical equipment for measurement, control and laboratory use – Part 1: General requirements (IEC 61010-1:2010)
EN 61010-2-010:2014	Safety requirements for electrical equipment for measurement, control and laboratory use – Part 2-010: Particular requirements for laboratory equipment for the heating of materials (IEC 61010-2-010:2014)
EN 61326-1:2013	Electrical equipment for measurement, control and laboratory use – EMC requirements – Part 1: General requirements (IEC 61326-1:2012)
EN ISO 12100:2010	Safety of machinery – General principles for design – Risk assessment and risk reduction (ISO 12100:2010)

The following national or international standards (or parts/clauses thereof) and specifications were applied: –

Name and address of the person who is authorised to compile the technical documents: Gillen, Tobias

Place: Stutensee / Date: 15.9.2016

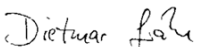
(Signature) Dietmar Gräbe

Certification

CE Mark

This product bears the CE mark in line with the provisions of Directive 2006/42/EC (Machinery Directive).



CAUTION

CE mark with connected products!

Products that are connected to this product must also bear the CE mark. These products must be test in accordance with the respective standards.

We declare conformity for sintering oven HTS-2/M/Zirkon-120 based on the following standards:

- Safety: EN 61010-1:2010 and EN 61010-2-010:2014
- EMC: EN 61326-1:2013
- Risk assessment and risk reduction EN ISO 12100:2010

EAC Certification



The Eurasian Economic Community Conformity Mark

Certificate number EAЭC N RU Д-DE.AД75.B.02156

RoHS Conformity



This symbol indicates that this product does not contain any poisonous or dangerous substances and can be recycled after disposal, and should not be thoughtlessly discarded.

Intended use

The **sintering oven** is a high-temperature oven for commercial use in dental laboratories and may only be used for sintering sinterable ceramics.



NOTICE

No liability is assumed for damage that may be caused by misuse, incorrect operation, incorrect connections or improper maintenance/repair work carried out by untrained personnel. All warranty services are also excluded in such cases.

Potential misuse

- Operation by untrained and insufficiently qualified personnel.
- Use of products that have not been approved by the manufacturer.
- Use of replacement parts that have not been approved by the manufacturer.
- Any use not in accordance with the declaration of conformity.
- Technical modifications to and conversions of the unit that have not been approved by the manufacturer.



NOTICE

Only sintering aids/accessories/wearing parts as well as spare parts approved by Mihm-Vogt may be used.

You can find an overview of the approved media and equipment on the supplementary sheet in your device packaging.

Technical data

Operating conditions

General information	
Dimensions (W x D x H)	390 x 500 x 790 mm
Combustion chamber volume	2 dishes Ø 120 x 30 mm
Max. temperature	1650 °C
Weight	60 kg
Minimum clearance around the sintering oven	50 mm
Connected electrical load	
Voltage supply	200-240 V (10% deviation)
Frequency	50-60 Hz
Max. power consumption	3.2 kW
Protection	
Device end	16 AT
Customer end	Connection to a separate electrical circuit with a 16-A circuit breaker, type K or type Z (other types of circuit breaker depending on the country of use)
Protection class	IP 20 (protection against the ingress of foreign bodies, but not against the ingress of water)
Operating conditions	
Installation area	Indoors only (in dry rooms)
Temperature range	+5 to +40 °C
Relative air humidity	Up to 31 °C: 80%
Maximum air humidity	Up to 40 °C: 50% No condensation
Height	Max. 2000 m
Pollution degree	2

Installation

Installation location

The **sintering oven** is designed as a table-top unit. A level surface of at least 50 cm x 60 cm that supports a load of up to 80 kg is recommended to ensure stability.

Installation conditions

- ▶ Always install the **sintering oven** in dry rooms that are as dust-free as possible and make sure that liquids cannot penetrate the unit.
- ▶ Highly inflammable and combustible gases and liquids must not be stored in the installation rooms.
- ▶ Do not place any combustible and inflammable objects near the **sintering oven**.
- ▶ Keep a distance of 50 mm around the sintering oven for sufficient cooling.



CAUTION

Tipping loads!

Supporting surface with an insufficient load-bearing capacity.

When installing the **sintering oven**, make sure that the supporting surface has a sufficient load-bearing capacity.



CAUTION

Risk of injury due to oven weight!

Physical strain/back injuries due to the high inherent weight.

- ▶ Have at least two persons carry/move the **sintering oven** together (max. 30 kg load bearing capacity/person).



CAUTION

Risk of overheating!

Overheating due to blocked air inlets

- ▶ Make sure that the air vents remain clear on all sides.

1. Align the supporting surface horizontally.
 2. Place the **sintering oven** on the supporting surface.
- ⚠ *Make sure the surface is non-slip.*
 - ⚠ *Lift and carry the sintering oven only at the unit base.*

Electrical connection

Local installation

- ☑ The **sintering oven** requires its own electrical circuit.
- ☑ The building's electrical circuit must have a type-K or type-Z circuit breaker with a rated current of at least 16 A (other types of circuit breaker depending on the country of use).
- ☑ An additional residual-current circuit breaker (designed for 30 mA tripping current) must be installed.
- ☑ To ensure electrically safe operation, the **sintering oven** requires a protective earth conductor to be connected to the power socket.
- ☑ When selecting the installation location, ensure that the accompanying mains cable is 2.0 m long. Extending the cable is not permitted. The supply voltage must be within the rated voltage range of 200-240 V.



DANGER

Electricity!

Risk of death from electric shock.

- Do not touch live cables and components with wet hands.
- Observe the accident-prevention regulations when working with electric current.
- Only connect the unit to a voltage supply that matches the specifications on the rating plate.



WARNING

Release of pollutants!

- Suitable respiratory protection must be worn when handling insulating material.
- If necessary, an extraction system must be installed.

Operation

Operating elements and displays





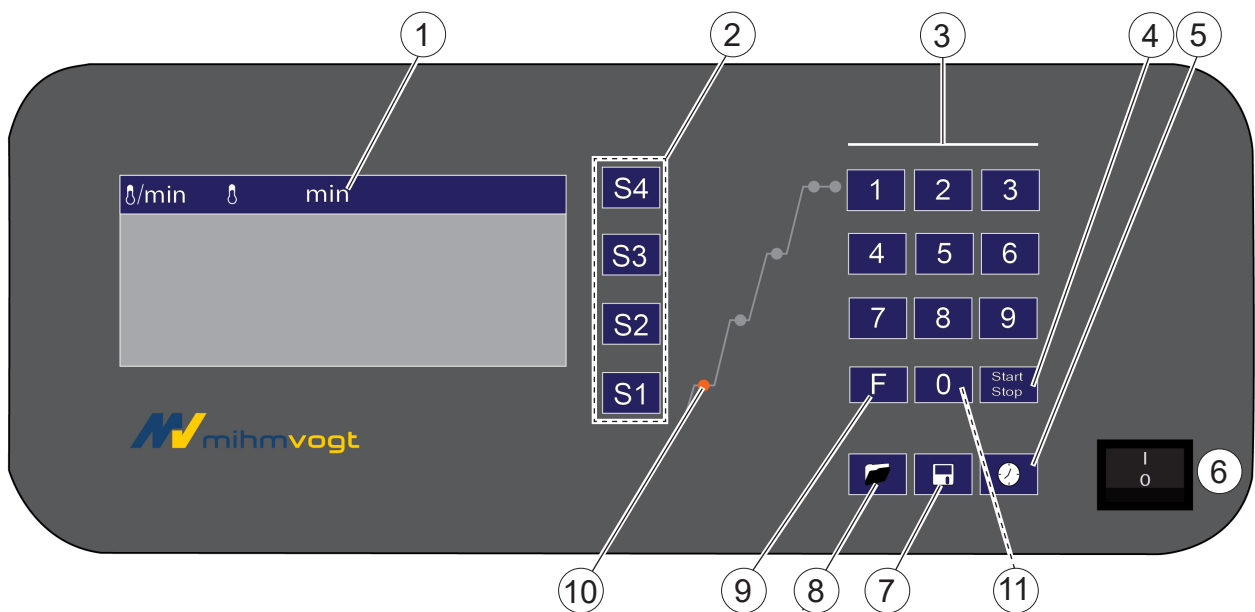

The microprocessor-controlled program controller enables a wide range of heating curves to be run through with high precision. The unit is operated via a membrane keyboard and menus displayed on an LCD screen.

The program controller has the following operating elements:



- | | |
|-------------------------|--|
| 1 Display | 6 Mains switch |
| 2 Heating levels | 7 Save button |
| 3 Numeric keypad | 8 Load button |
| 4 Start/Stop button | 9 Function button |
| 5 Finishing time button | 10 Heating phase LEDs |
| | 11 Additional function: Open oven door |

Switches and button functions

Function	
	Mains switch
	Starts/stops the current heating program
	Loads an existing program from the memory
	Saves a created program in the memory
	Setting the finishing time
	Function button for setting the parameters (see graphic "Parameter settings" on page 32)
	<p>Additional function: Open oven door</p> <p>This additional function is only active if the current oven temperature is less than the set temperature in level 4.</p>

Standby screen

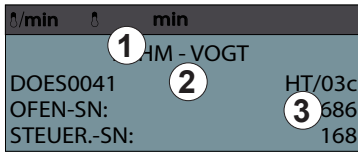

- 1 Manufacturer
- 2 Information on hardware and software status
- 3 Serial number of oven



- 1 Heating rate in °C/min. (°F/min.)
- 2 Set final temperature of level
- 3 Set holding time of level

Switch on Sintering Oven

1. Connect the voltage supply.
 2. Switch the **sintering oven** on at the mains switch.
- ⇒ The current temperature of the oven is displayed after approximately 3 seconds.
 - ⇒ The oven door opens automatically.

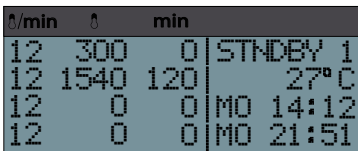

Program slot structure

- | | |
|---------|--|
| 1...14 | No special function |
| 15...20 | Ventilation heating |
| 21...25 | Preliminary drying |
| 26...30 | No special function |
| 31 | Service A - Temperature control |
| 32 | Service C - Heating chamber cleaning |
| 33 | Service E - Heating element regeneration |

Initial commissioning



NOTICE

Check the basic settings of the *sintering oven* (see “Basic settings” on page 32).

Using the door insulation

1. Insert the connecting pins (Pos. 2) into the base support (Pos. 1).
2. Place the support (Pos. 3) on the connecting pins (Pos. 2).
3. Place the centring pin (Pos. 4) in the centre of the support (Pos. 3).
4. Place the support disc (Pos. 5) on the support (Pos. 3) with the centre hole downwards onto the centring pin (Pos. 4).
5. Insert the complete door panel in the oven door.

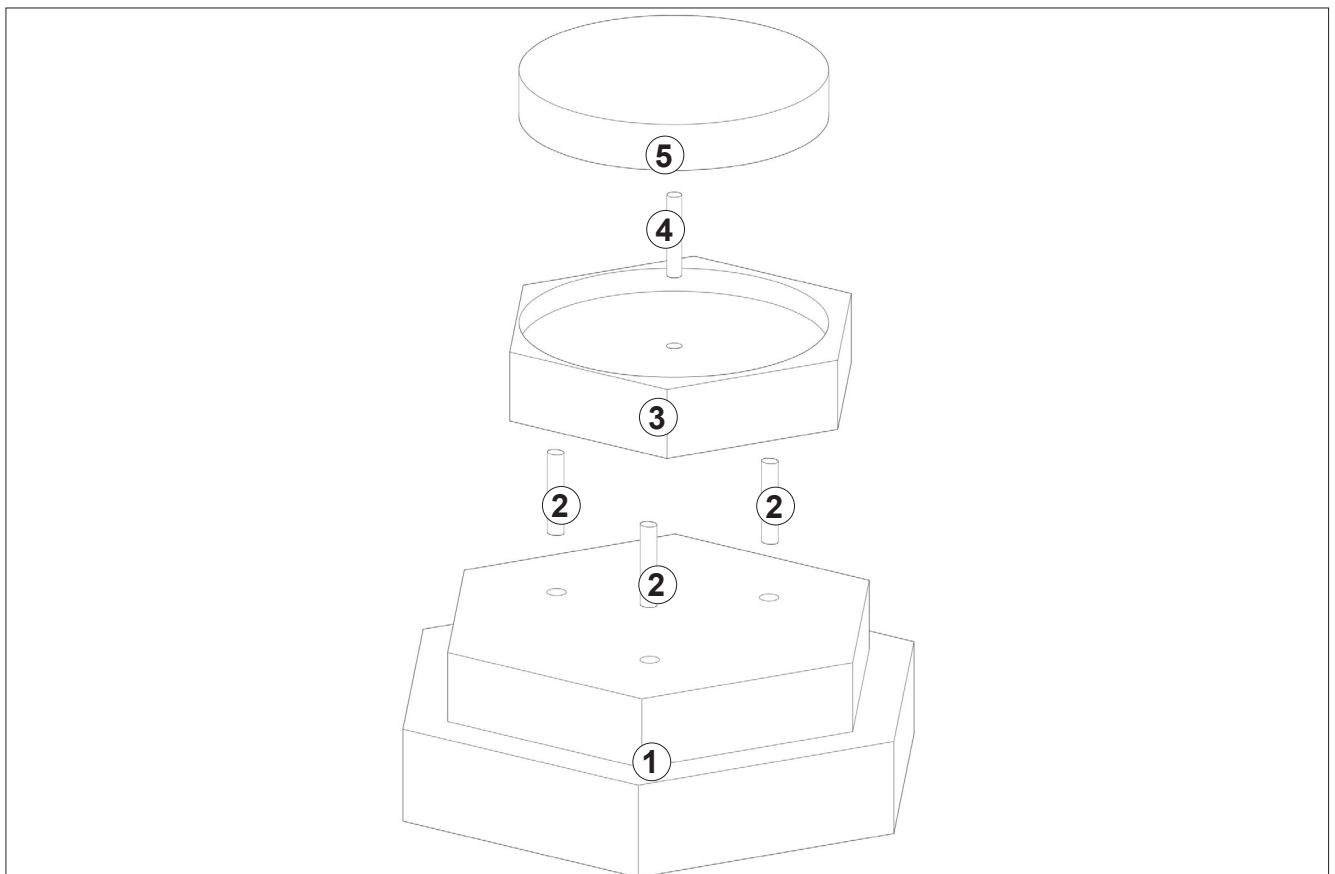

Sintering aids



NOTICE

Only use sintering aids approved by Mihm-Vogt.

You can find application notes in the information flyer for the relevant sintering aid.

Sintering process

Sintering OvenFeeding

⚠ *The ceramic door panel is extremely porous and sensitive to scratching and impacts.*

⚠ *Do not grip the door panel with extraction pliers.*

1. Switch the **sintering oven** on.

➡ The oven door opens automatically.

2. Fill the sintering dish (included in the delivery) with sintering granulate.

3. Place the item to be sintered in the sintering dish.

4. Place the equipped sintering dish on the support disc using suitable crucible tongs.

Start
Stop

5. Start a firing program by pressing the **START/STOP** button.

➡ The oven door closes automatically.



CAUTION

Risk of crushing limbs!

The oven door closes automatically.

- Only press the **START/STOP** button after the filled sintering dish has been positioned.
- Make sure that nobody reaches between the oven door and heating chamber while the oven door is closing.



NOTICE

Recommendation for use of the sintering dishes provided:

- Use of sintering dish SPEED 120/30 mm at heating rates greater than 25°C/min.
- Use of sintering dish 120/30 mm at heating rates of 25°C/min and lower.

Selecting and loading a heating program



1. Press the **LOAD** button.

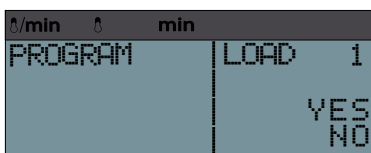

- The **LOAD PROGRAM** menu opens.
- The sintering oven loads the heating program last used



2. Press the **S4** button until the required heating program is reached or enter the desired heating program via the numeric pad.



3. Press the **S2** button for "YES" to confirm the loading.

- The loaded heating program is displayed.



4. Press the **S1** button for "No" to cancel the loading.

- The heating program last loaded is displayed.

Starting/stopping a heating program

Requirements

- Sintering oven** is filled
- Heating program is loaded



1. Press the **START/STOP** button.

- The heating program starts.
- The oven door closes automatically.

- ➔ The status display changes from **READY** to **SEQUENCE**.
- ➔ The process status is also shown in a level diagram:

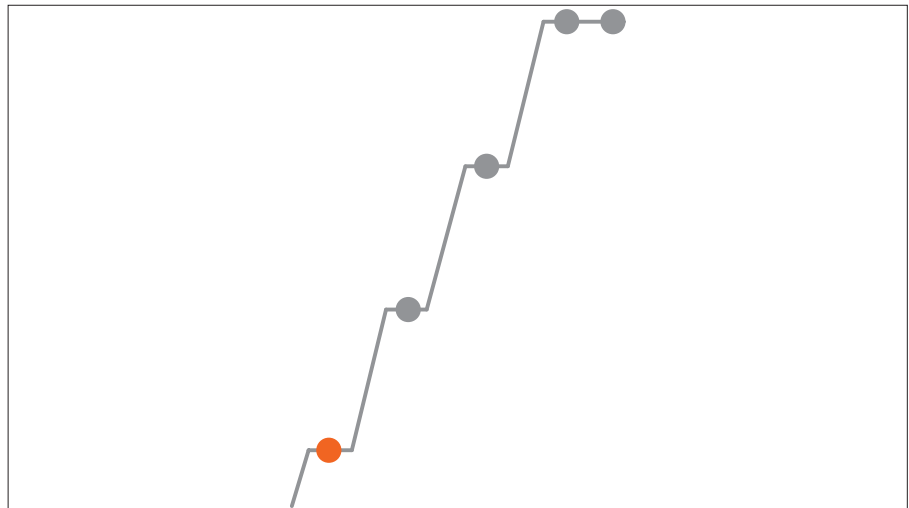

Start
Stop

2. Press the **START/STOP** button again.

- ➔ The heating program is stopped.
- ➔ The status display changes from **SEQUENCE** to **READY**.

Start
Stop

3. Press the **START/STOP** button again to continue the heating program.

Removing the sintering dish from the heating oven

Requirements

- The oven door is open

1. Guide suitable crucible tongs under the sintering dish and lift it off the support disc.
2. Place the sintering dish on a suitable heat-resistant surface.

Programming the heating levels

The control provides the option of setting the *sintering oven* heat-up in 1-4 heating levels as a heating program. Heating and cooling is possible within a heating program.

If no setting is made within one minute during the programming, the cursor will disappear and an acoustic signal sounds.

S1

1. Press the **S1** button.
 - The cursor for entry flashes in the 0/min field.
2. Enter the heating rate using the numerals 0-9. The minimum heating speed is $1^{\circ}\text{C}/\text{min}$ ($2^{\circ}\text{F}/\text{min}$), the maximum heating speed is $99^{\circ}\text{C}/\text{min}$ ($178^{\circ}\text{F}/\text{min}$).
 - If the entry is below a two-digit value, the cursor must be moved over the relevant level button to the next input field.
 - After entering the heating rate, the cursor skips to the next input field.
3. Use the numerals 0-9 to enter the four-digit holding temperature that the oven is to heat up to in the heating level **S1**.

NOTICE

The maximum programmable temperature of the *sintering oven* is 1650°C .

If a higher temperature is entered, the display skips back to the previous value.

- After entering the temperature value, the cursor skips to the next input field.
- If the entry is below a four-digit value, the cursor must be moved over the relevant level button to the next input field.

4. Enter the holding time in minutes using the numerals 0-9.

NOTICE

The maximum programmable holding time is 999 minutes.

- ➔ After all three values have been entered, the programming for heating level 1 is completed.

Programming levels S2 to S4

To program further heating levels, follow the steps from the first heating level with the corresponding heating level button (e.g. **S2** for the second heating level, **S3** for the third heating level, etc.).

If you do not require all 4 heating levels, the temperature must be set to zero in the level not used.

Level **S1** to **S3** can be at zero.

Level **S4** controls the door opening temperature and must be entered.

Saving the heating program

The *sintering oven* can save up to 30 different heating programs.

Saved heating programs are also retained after switching off the *sintering oven*.

A heating program is always saved under the program number under which it was previously loaded.



1. Press the **SAVE** button.

- ➔ The **SAVE** menu is displayed.

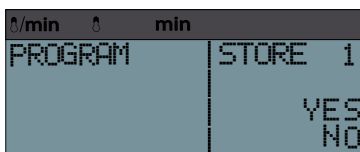

2. Press the **S2** button for “YES” to save the heating program.



3. Press the **S1** button for “No” to cancel the saving.

Linear cooling



NOTICE

The sintering oven enables linear cooling by automatically opening the oven door incrementally below 1200°C. For this, the cooling phase must be programmed in level 4 (and level 3 for multistage cooling phase).

The oven door is only opened fully after the end of the program.

Saving the heating program with a name

To uniquely identify a specific heating program, it can be saved with a name you can freely choose.



1. Press the **SAVE** button.

➞ The **SAVE** menu is displayed.

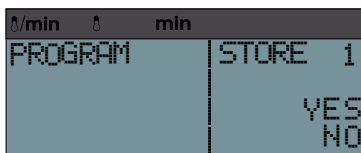

2. Press the **FUNCTION** button to change the first letter. Pressing this button repeatedly toggles through the alphabet from A to Z.



3. Press the **S4** button to skip to the next letter.



4. After you have entered the desired name, press the **S2** button to save the changes.

Renaming the heating program

Requirements

- The program values are entered for all levels.



1. Press the **SAVE** button.

- ➔ The **SAVE** menu is displayed.

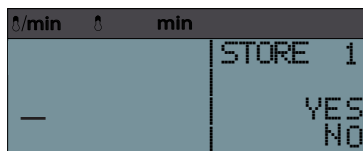

A memory name with up to four lines can now be saved in the left field.

- ➔ You can use the **S4** button to move the cursor incrementally to the right.



Starting a heating program automatically

The **Sintering Oven** can be programmed via an integrated timer so that it finishes the heating program currently loaded at a specific finishing time. The integrated timer is used to specify the day and time at which a program should finish.

1. Select a heating program.



2. Press the **FINISHING TIME** button.

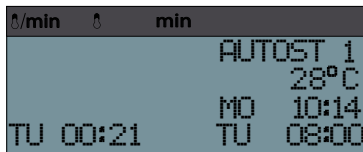

3. The **AUTOSTART** program opens.



3. Press the **S1** button to enter the day of the week. Set the days of the week using buttons 1-7 (1 = Mon, 2 = Tue, 3 = Wed, etc.).



4. Press the **S1** button again to skip to the time entry.

5. Set the hours using buttons 0-9.



6. Press the **S1** button to change to the minutes display.

7. Set the minutes using buttons 0-9.

8. The timer is activated.

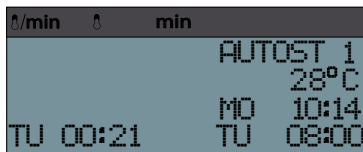

9. The finishing time as well as the calculated switch-on time are shown in the display.

Special functions

Sintering with ventilation

This additional function is used for extra ventilation of the combustion chamber during the sintering process, this having a positive effect on the oxidation process.

This function is only possible with program slots 15-20.

Preliminary drying without sintering

°/min	°	min	
12	0	0	STNDBY27
12	0	0	27°C
12	0	0	MO 14:12
12	300	30	MO 21:51

During the preliminary drying, the oven door remains open one large gap in the first program level **S1**. Preset program slots are provided by default for the preliminary drying. As a result, you can only perform this function on these slots. The special function is only active on slots 21-25.

Values may only be entered in level **S1** for the preliminary drying without sintering. No values are assigned to levels **S2-S4** for holding temperature and holding time. If value are nevertheless to be set for levels **S2-S4**, these must be reset to "0".

Only the holding time can be changed in level S1!

Preliminary drying with sintering

°/min	°	min	
12	300	0	STNDBY27
12	1540	30	27°C
12	0	0	MO 14:12
12	300	00	MO 21:51

The same function is usually saved for the preliminary drying with sintering, as for the preliminary drying without sintering. This means the oven door remains open one large gap in the first program level **S1** during the preliminary drying. Consequently this special function is also saved on program slots 21-25. To add sintering to this function, the desired values are also set in levels **S2-S4**.

Basic settings

Parameter settings

The time and heating parameters of the *sintering oven* are preset and pre-programmed at the factory.

The *sintering oven* does not switch to summer/winter time automatically.

1. Switch the *sintering oven* on at the mains switch.

F

2. Press the **FUNCTION** button.

↻ The Parameters menu opens.

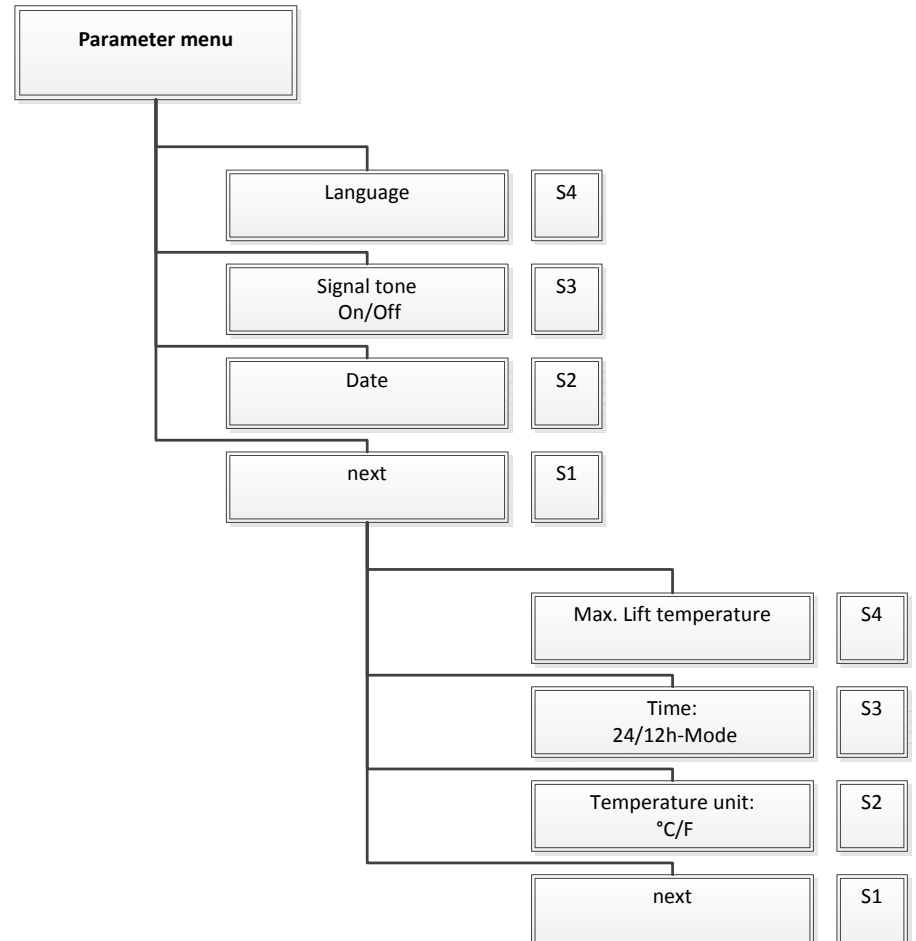

3. Press a button (**S1-S4**) to select a parameter.
4. Press the corresponding parameter button several times until the desired change is reached.

Parameter	But-ton	Function
Language	S4	Change system language (DE, EN, FR, IT, ES, DA, CZ, NL)
Acoustic signal	S3	Switch acoustic signal on/off
Date	S2	Set day and time
Next	S1	Skip to the next Parameters menu Level 2:
Max. adjustable lift opening temperature	S4	Serves as second line of safety. The lift opening temp. is set in level 4.
Time scheme	S3	Time display 12/24h mode
Temperature scale	S2	Temperature unit °C/°F
Next	S1	Quit Parameters menu

Setting the day and the time

F

1. Press the **FUNCTION** button.

S2

2. Press the **S2** button.

S2

3. Set the days of the week using buttons 1-7 (1 = Mon, 2 = Tue, 3 = Wed, etc.).

4. Press the **S2** button to change to the hours display.

5. Set the hours using buttons 0-9.

S2

6. Press the **S2** button to change to the minutes display.

7. Set the minutes using buttons 0-9.



NOTICE

A change made is only accepted if the cursor is no longer visible.

Setting the lift temperature

F

1. Press the **FUNCTION** button.

S1

2. Press the **S1** button.

➔ The second Parameters menu opens.

S4

3. Press the **S4** button.

4. Set the lift temperature using buttons 0-9.

➔ Adjustable range 100°C to 300°C

Switching off Sintering Oven

1. Switch the *sintering oven* off at the mains switch.



CAUTION

Risk of burns from the residual heat of the high-temperature oven!

The heating chamber can retain a significant amount of residual heat even when the *sintering oven* is switched off. There is a risk of burns from the heating chamber walls and the oven door.

Therefore:

- Make sure the *sintering oven* has cooled down sufficiently before carrying out any work on it. It takes at least 4 hours for the *sintering oven* to cool down from the maximum temperature to around room temperature.

RS-232 interface

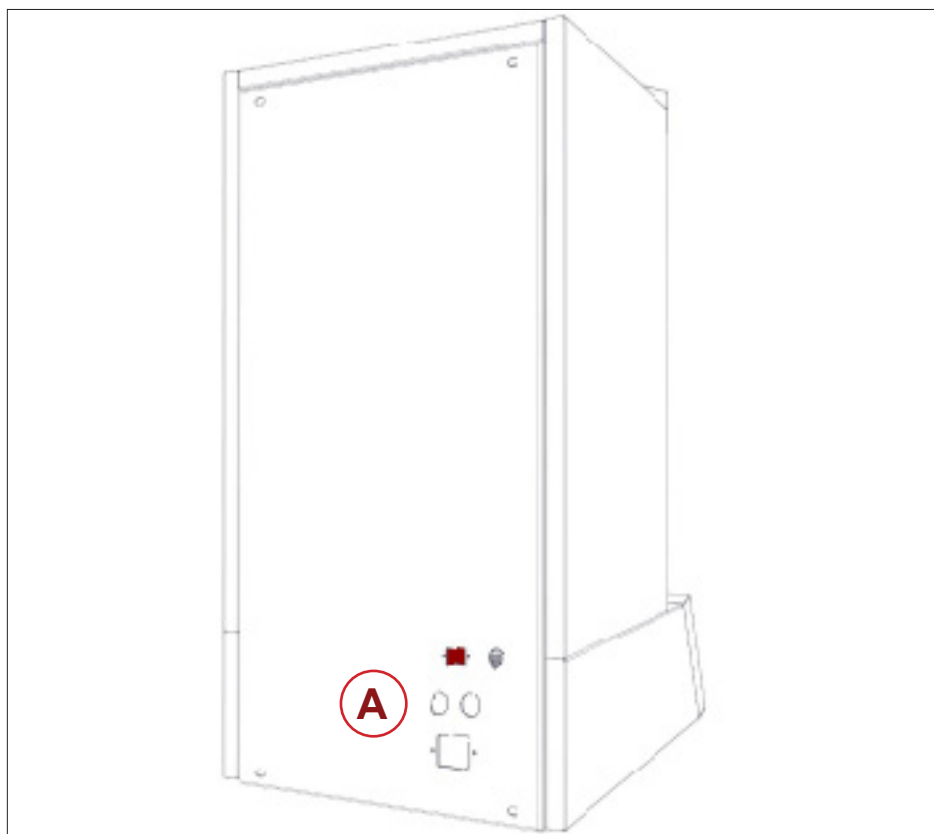

The sintering oven has an RS-232 interface (A) on the rear, which is used to save log files on a computer.

Requirements

- RS-232 interface cable
- Computer with RS-232 connection option
- Software “uCon” (available under: <http://www.umonfw.com/ucon/>)
- Microsoft Excel licence

NOTICE

If the computer to be used has no RS-232 connection option, a USB adapter with installation CD can be ordered from the manufacturer.

In this case contact the Mihm-Vogt customer service.

1. Connect the sintering oven to the computer using the connecting cable.
2. Start the “uCon” software.

- Set the configuration shown.

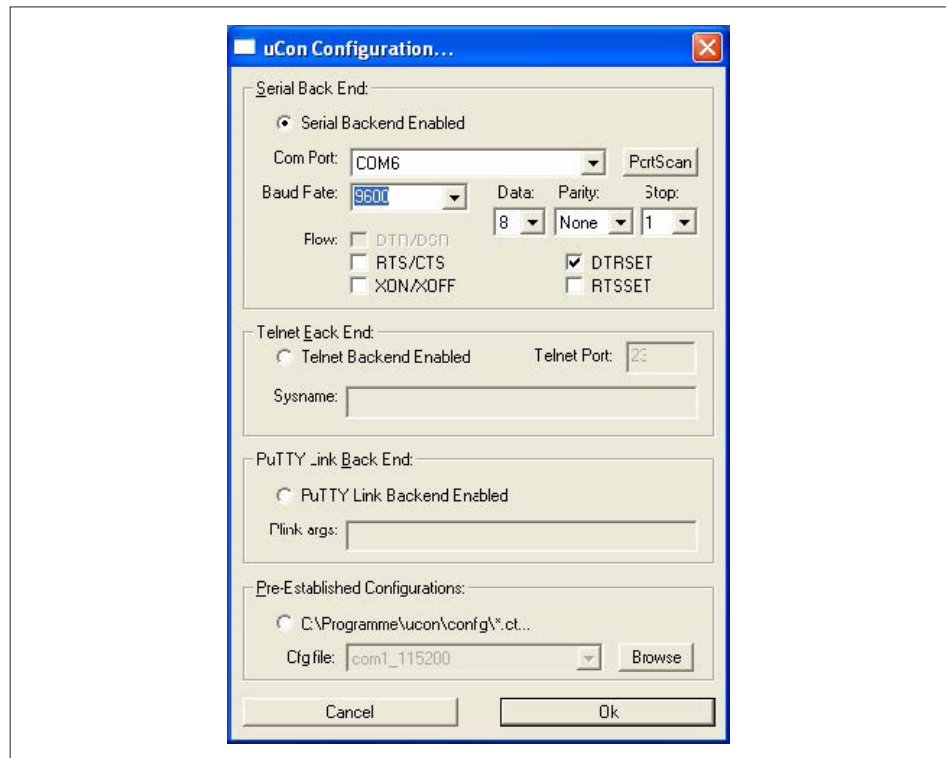

- If the "Com Port" is not known, select a suitable one with "PortsCan".
- Confirm your entry with "OK".
- Save your port configuration in the "File" menu and "Save As...".

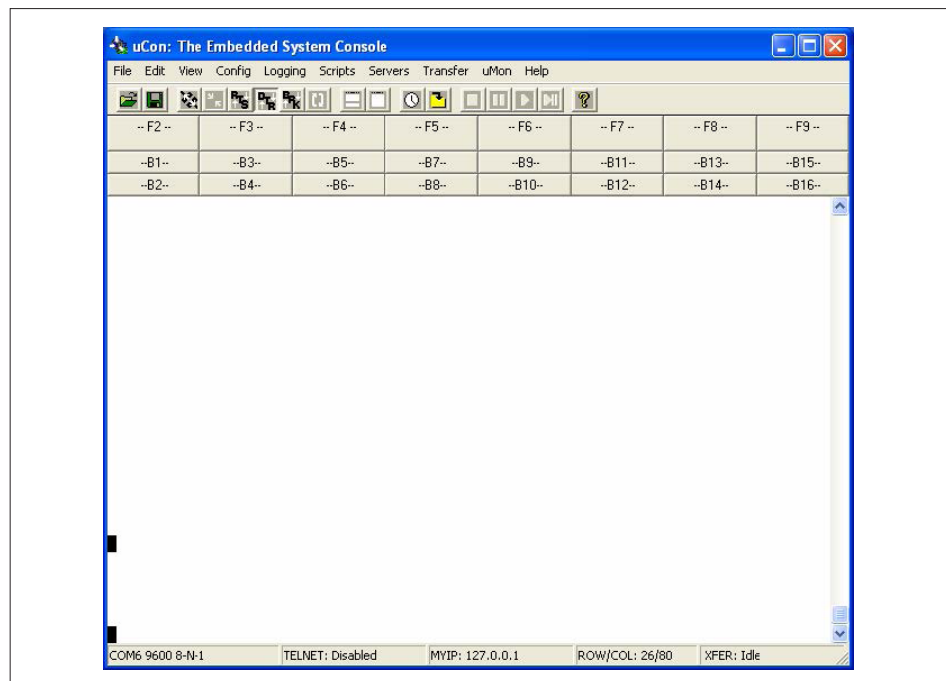

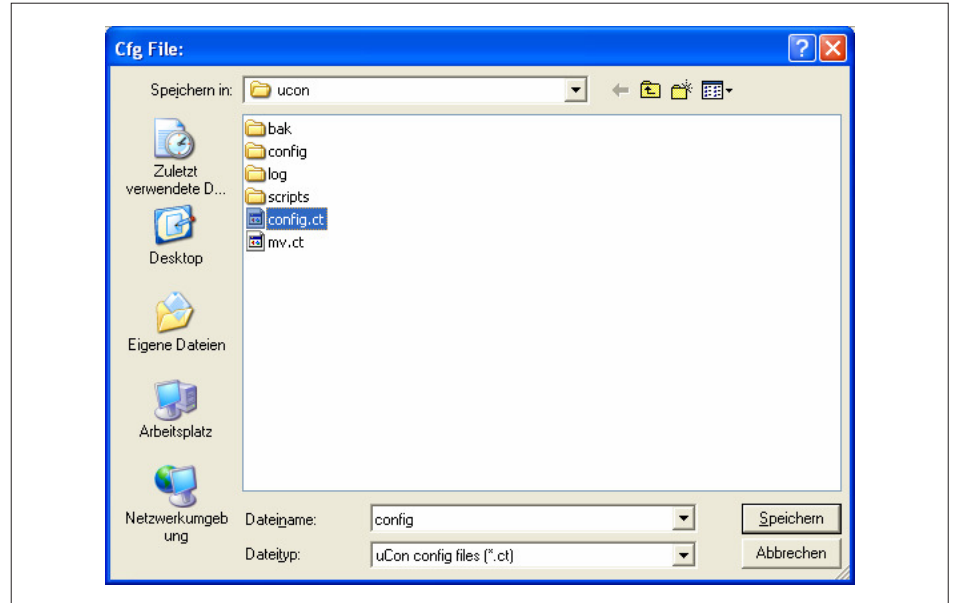

7. Configure the logging:
 - ▶ Select the “Standard” option in the “Logging” menu.
 - ➞ The configuration window is opened.
8. Set the checkmark as shown and give the TXT file a name.

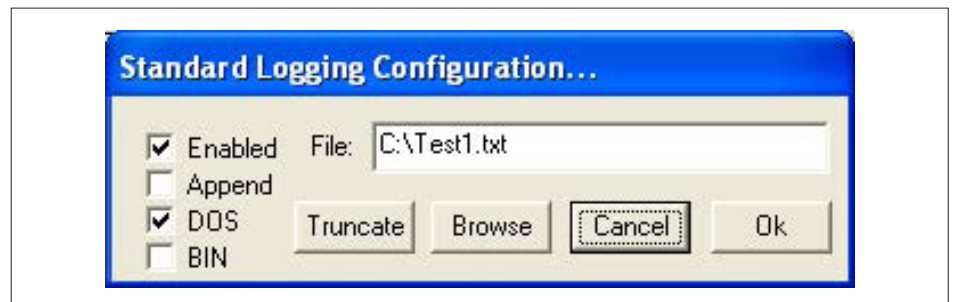

9. Confirm with “OK”.
10. Start the sintering program at the sintering oven.
 - ➞ The sent data is displayed.
The target temperature appears in the left column, the actual temperature in the right column.

11. Click on the X button to write the data to the known TXT file (here Test1.txt).
12. The logging is terminated by clicking on the button.

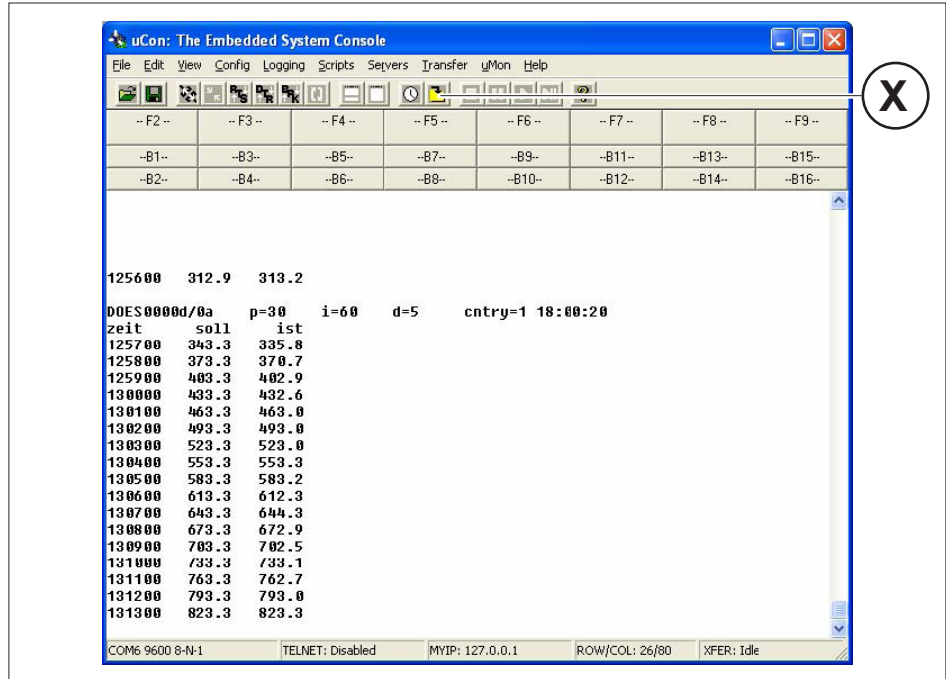

13. Call up Microsoft Excel to create a graphic.
14. Import the generated text file.

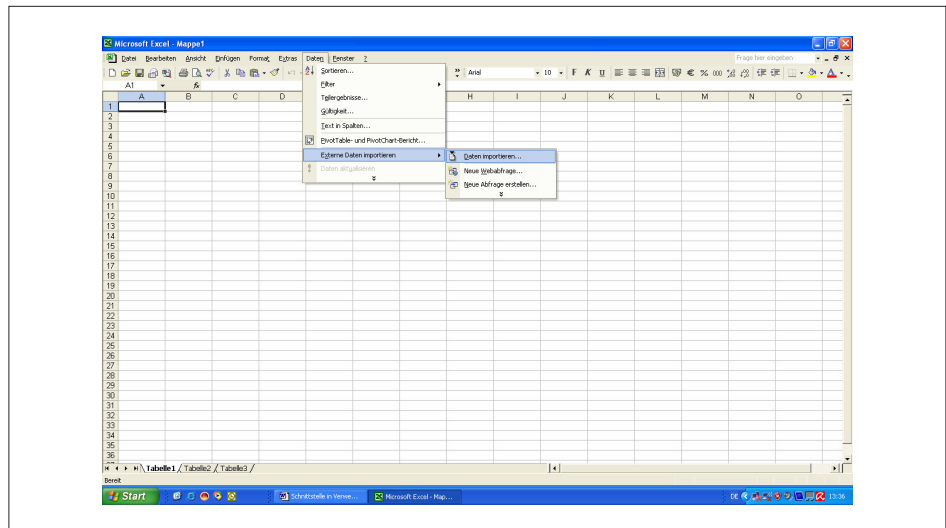

- ➡ The Text Conversion Assistant opens.

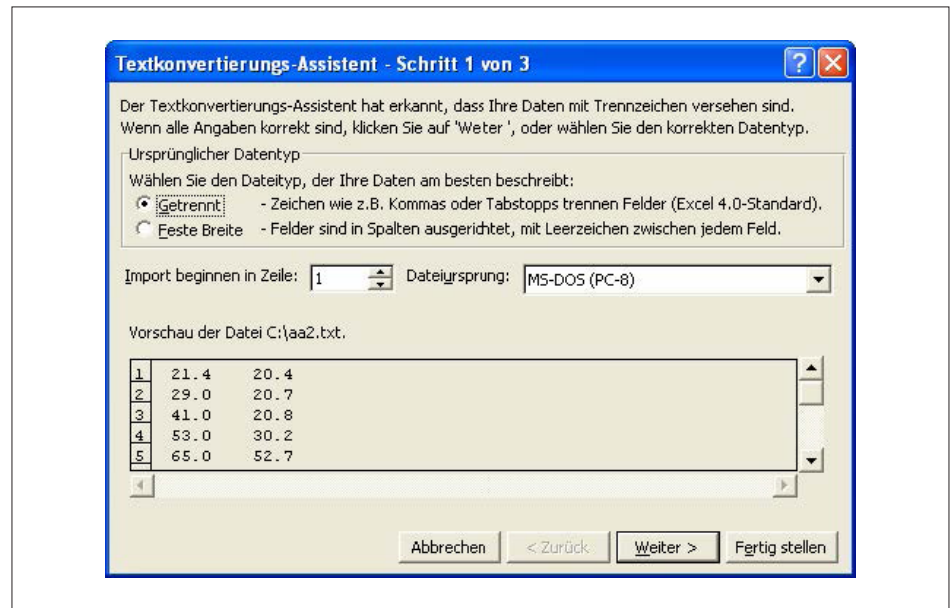

- Click on "Next" and make the following settings:
- Set the checkmark at "Space".

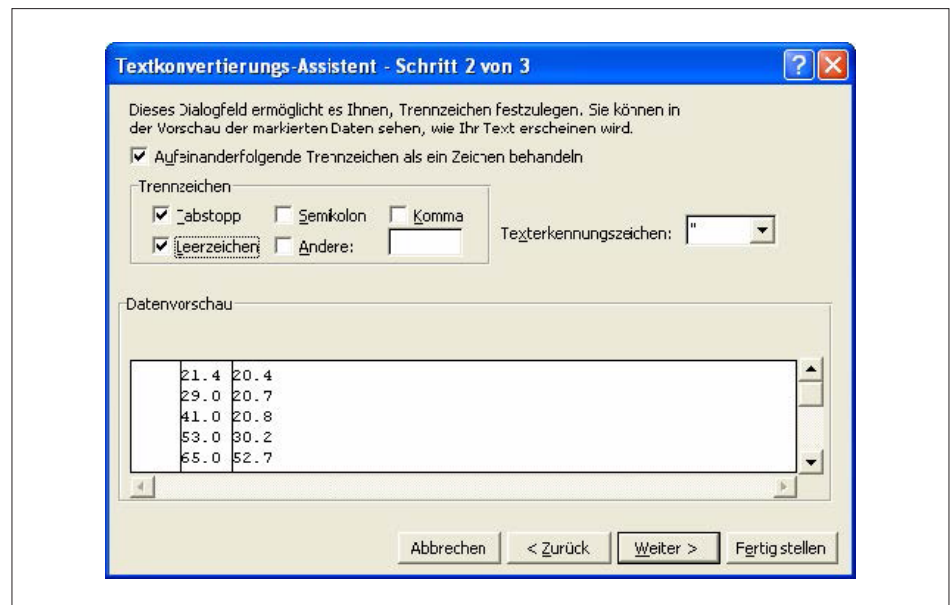

- Click on the "Next" button.

18. Click on the “More...” button.

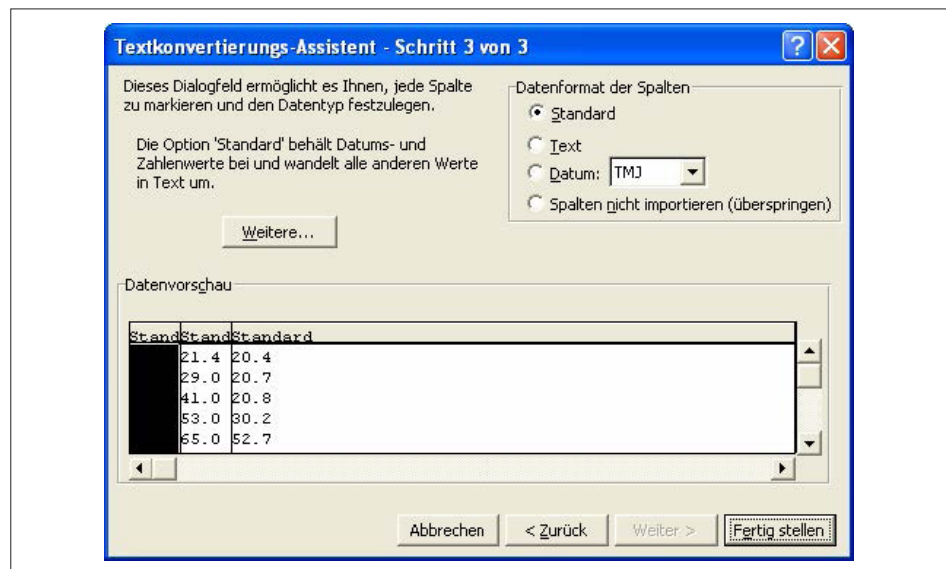

19. Permute point and comma for both settings and confirm with “OK”.



20. Click on the “Finish” button and “OK”.



21. The data series are displayed.

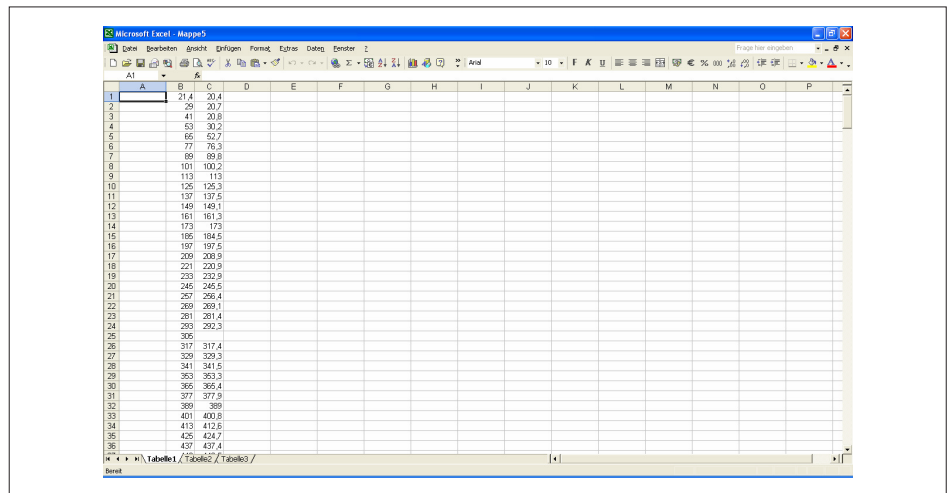

22. Select the Diagram Assistant and choose a diagram type (e.g. line).

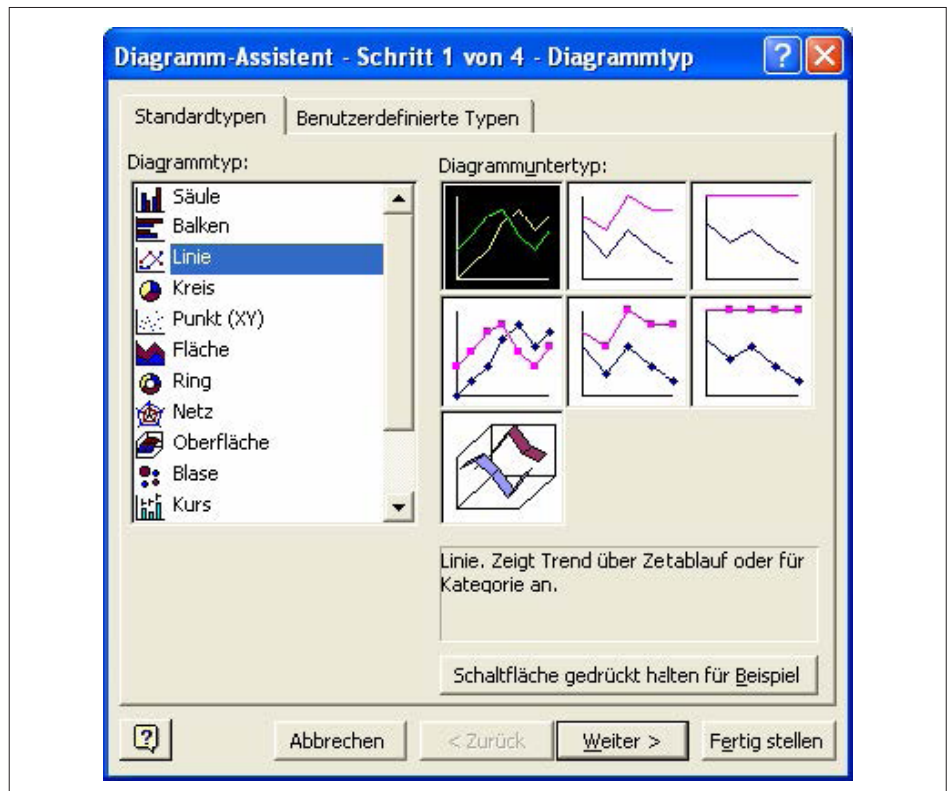

23. Click on “Next” three times and then “Finish”.

24. The finished diagram is displayed.

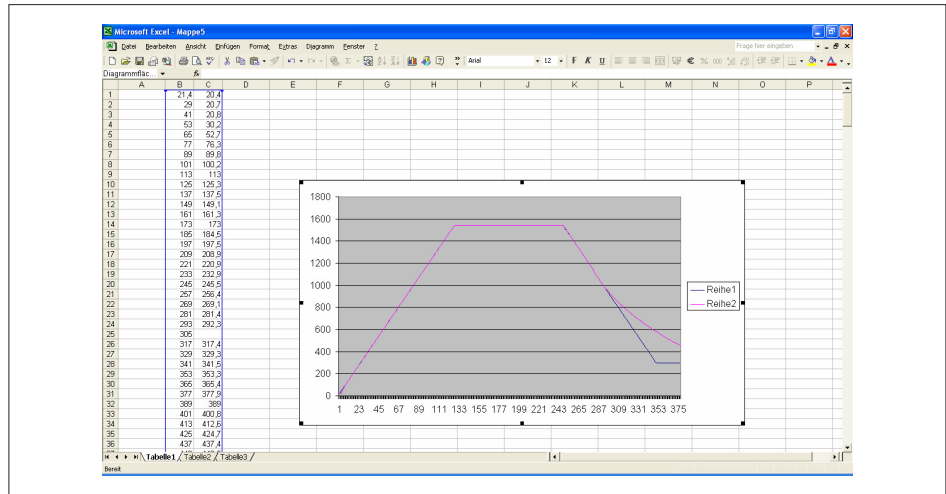

Care and maintenance

Clean the housing of the *sintering oven* every so often with a damp cloth.



NOTICE

Damage to the heater!

- Make sure the heating chamber does not become dirty. This could damage the heater.



NOTICE

Use of colouring liquids affects the unit's service life!

During the sintering process, the use of colouring liquids can significantly shorten the service life of the heating elements.

Service programs

A cleaning cycle should be run periodically depending on how often the oven is used. This serves to remove contamination due to liquids and other impurities that become deposited in the insulation.

Depending on the frequency of use, a regeneration cycle should also be carried out, which is necessary for regeneration of the heating elements.

Service programs can be selected on program slots 31-33.

Program slot

- 31 Service A - Temperature control¹
- 32 Service C - Heating chamber cleaning
- 33 Service E - Heating element regeneration

¹ Only in conjunction with test kit

Faults and error messages

Safety



DANGER

Electricity!

Risk of death from electric shock.

- Work on electrical systems may be performed by qualified electricians only.
- Before carrying out any installation, maintenance, cleaning or repair work, disconnect the power supply of the **sintering oven** and secure it against being switched back on.
- Do not touch live cables and components with wet hands.
- Observe the accident-prevention regulations when working with electric current.



WARNING

Hot surfaces!

Risk of serious burns to the limbs.

- Do not touch the housing or the oven door during operation.
- Ensure that the **sintering oven** has cooled down completely before carrying out maintenance, cleaning and repair work.
- Wear heat-resistant, thermally insulated safety gloves when it is necessary to carry out work on hot components.





NOTICE

Material damage due to incorrect repair of electric cables!





This may cause malfunctions and make electric components defective.

- Do not repair defective cables or plugs.

Faults

Fault	Possible cause	Troubleshooting	Responsibility
Incorrect time	The time in the controller has been saved incorrectly	Set the correct time	User
Sintering Over Sintering oven does not start automatically	Power failure/ Interruption of the power supply	Check power supply for absence of interruption, notify a qualified electrician, if necessary	
No indication on the display, level LEDs do not light up	There is no power supply	Check the on-site circuit breakers Check connection cable, notify a qualified electrician, if necessary	
Pieces broken out of door panel, other damage to the door filling	Improper handling of the door panel	Replace door panel	
Display "Power failure"	Mains interruption during the sintering process for more than 10s	Acknowledge with Start/ Stop button	
No display, the level LEDs light up briefly when switching on	Defective display	Replace controller	Service Department 
Level LED flashes, but oven does not heat	Defective heater	Check heater for continuity	Service Department 

Error messages in the electronics

Fault	Possible cause	Troubleshooting	Responsibility
Display: "Sensor defective"	Defective thermocouple	Replace thermocouple	Service Department 
	Loose thermocouple connections	Retighten thermocouple connections	
Display: "Sensor + <-> -"	Oven inside temperature is much colder than room temperature	Open oven door to allow the inside of the chamber to reach room temperature.	User
	Thermocouple connected incorrectly/wrong polarity	Replace thermocouple connections	Service Department 
Display: "Safety shut-down"	Oven temperature is above 1650 °C	Switch off oven and allow to cool down. Inform Service if the fault occurs again.	User
Display: "Sensor short-circuit"	Temperature sensor defective	Call Customer Service	Service Department 
Display: "Thyristor defective"	Defect in the electronics	Call Customer Service	Service Department 
Long acoustic signal without LCD display, oven door does not close, program does not start	Calibration of the door switch not correct	Call Customer Service	Service Department 

Decommissioning

Decommissioning can be carried out for two reasons:

- For the purpose of reinstalling the unit at another location.
- For the purpose of final disposal.

If the **sintering oven** is to be reinstalled at another location, decommissioning must be well prepared. All components and fittings must be carefully removed, labelled and, if necessary, packaged for transport. This ensures that all parts can be identified correctly and refitted in the correct positions when reassembling the unit.

1. Switch the **sintering oven** off.
2. Disconnect the **sintering oven** from the voltage supply.
3. Remove all connections (e.g. PC interface cable, etc.) from the **sintering oven**.

Disposal

Safety



WARNING

Release of pollutants!

Pollutants can be inhaled when the insulating materials are handled.

- Wear personal protective equipment (respiratory protection) during disposal.



WARNING

Potential contamination of the environment and groundwater due to improper disposal!

- The regulations and guidelines of the legislature in the country of operation must be complied with when disposing of parts of the unit and operating materials.

Disposal

1. Sort the component parts of the **sintering oven** into recyclable materials, hazardous substances and operating materials.
2. Dispose of the component parts of the **sintering oven** or take them to be recycled.

